

Date:	Approved:
Type:	
Fixture:	
Project:	

# SSC6 Six-Inch Round Seamless Indoor Cylinder

Standard Drivers without Battery Backup

Select options next to clock symbol to qualify your order.

**QuickShip max order = 25 pcs**



## FEATURES

- Up to 8000 lumens (4000K)
- Multiple dimming options
- Tool-less field interchangeable optics
- No visible seams or fasteners
- Multiple housing colors
- 93 CRI with 2 SDCM

## PERFORMANCE

**Beam Spread:** 15°, 25°, 40°, 50°, 72°, Wall Wash  
**CCT Options:** 2700K, 3000K, 3500K, 4000K  
**CRI:** 93 CRI  
**Consistency:** 2 SDCM (Luminaire to Luminaire)  
**Lumens:** 500 - 8000 lumens (nominal)  
**Lumen Maintenance:** L70 >70,000 hours



## PHYSICAL

**Mounting:** Aircraft cable, cord, slope pendant, surface, wall, yoke w/ twist-lock canopy or through drywall using optional mud ring adapter.

**Housing:** No visible seams or fasteners, marine grade, corrosion resistant, solid aluminum extrusion, high pressure die-cast aluminum components, black baffle.

**Finish:** Six stage chemical iron phosphate conversion pre-treatment. Polyester powder coat finish, 18 µm Min., 3,000 hour salt spray test (ASTM B117) AAMA 2603 specification.

**Warranty:** 5-Year limited warranty

**Lens:** IK05 impact compliant, clear anti-glare impact resistant optics. The Soft Field Lens option provides diffusion, reduces glare, and enhances visual comfort.

**Ingress Protection:** Dry or damp locations IP43 rated

**Weight:** 4-10 lbs (Depending on Length)

**Operating Temperature:** -22°F to 113°F (-30°C to 45°C)

## ELECTRICAL

**Voltage:** Universal 120 - 277 VAC, 347 VAC optional

**Power Supply:** Integral Class II, electronic high-power factor >.90, THD < 20%, FCC Title 47 Part 15 Class A.

**Power Consumption:** Maximum 81W

**Dimming:** standard: 0-10V, 1%, optional: ET, XCR

**Standards:**

- cETLus Listed, CE, NOM, and RoHS Compliant.
- Tested to UL 1598 and UL 8750 standards / UL-Class I / IES LM-79 / LM-80 / FCC Part 15.

## PHYSICAL DIMENSIONS

Luminaire	Height	Aircraft Cable (AC)	Cord (CM)	Surface Mount (SF)	Pendant Mount (SPM)	Wall Mount (WM)	Yoke (Y)
SSC6-08	8" Height						
SSC6-10	10" Height						
SSC6-12	12" Height						
SSC6-14	14" Height						
SSC6-16	16" Height						
SSC6-18	18" Height						

Due to continuous development and improvements, specifications are subject to change without notice. Product use certifies agreement to Solid State Luminaires terms and conditions.

# SSC6 Six-Inch Round Seamless Indoor Cylinder

## PRODUCT CODE

EXAMPLE: SSC6-8-SPM18-UNV-930-05L-BKI-15-LD

QuickShip max order = 25 pcs



Select options next to clock symbol to qualify your order.

MODEL	HEIGHT	MOUNTING	SUSP. LENGTH	VOLTAGE	COLOR	LUMENS	FINISH	OPTIC	DIMMING	OPTIONS	
SSC6											
<b>MODEL</b>				<b>COLOR</b>				<b>OPTIC nominal</b>		<b>w/SOFT FIELD</b>	
<input checked="" type="checkbox"/> <b>SSC6</b>				<b>927</b> (93CRI) 2700K <input checked="" type="checkbox"/> <b>930</b> (93CRI) 3000K <input checked="" type="checkbox"/> <b>935</b> (93CRI) 3500K <b>940</b> (93CRI) 4000K Other CCT/CRI available upon request.				<input checked="" type="checkbox"/> <b>15</b> Spot (15°) <input checked="" type="checkbox"/> <b>25</b> Mid Spot (25°) <input checked="" type="checkbox"/> <b>40</b> Narrow Flood (40°) <input checked="" type="checkbox"/> <b>50</b> Flood (50°) <input checked="" type="checkbox"/> <b>72</b> Wide Flood (72°)		<b>15S</b> Spot (15°) <b>25S</b> Mid Spot (25°) <b>40S</b> Narrow Flood (40°) <b>50S</b> Flood (50°) <b>72S</b> Wide Flood (72°) <b>WW</b> Wall Wash (50° Optic Only)	
<b>HEIGHT</b>				<b>LUMENS nominal</b>				<b>DIMMING</b>			
<b>8</b> 8" Height <input checked="" type="checkbox"/> <b>10</b> 10" Height <b>12</b> 12" Height <b>14</b> 14" Height <b>16</b> 16" Height <b>18</b> 18" Height				<b>05L</b> 500 lm <b>10L</b> 1000 lm <input checked="" type="checkbox"/> <b>15L</b> 1500 lm <input checked="" type="checkbox"/> <b>20L</b> 2000 lm <input checked="" type="checkbox"/> <b>25L</b> 2500 lm <input checked="" type="checkbox"/> <b>30L</b> 3000 lm <input checked="" type="checkbox"/> <b>35L</b> 3500 lm <b>40L</b> 4000 lm <b>45L</b> 4500 lm <b>50L</b> 5000 lm <b>55L</b> 5500 lm <b>60L</b> 6000 lm (Minimum 12" H) <b>65L</b> 6500 lm (Minimum 12" H) <b>70L</b> 7000 lm (Minimum 12" H) <b>75L</b> 7500 lm (Minimum 14" H) <b>80L</b> 8000 lm (Minimum 14" H)				<input checked="" type="checkbox"/> <b>LD</b> 0-10V Dimming, 1% <b>ET</b> ELV or TRIAC Driver (Only 05L-50L, 120V Phase Dimming Only with UNV Driver)			
<b>MOUNTING</b>						<b>FINISH</b>				<b>OPTIONS</b>	
<input checked="" type="checkbox"/> <b>AC</b> Aircraft Cable <b>CM</b> Cord Mount (14" Maximum) <input checked="" type="checkbox"/> <b>SF</b> Surface Mount <b>SPM</b> Pendant Mount <b>WM</b> Wall Mount <b>Y</b> Yoke (18" Maximum)						<input checked="" type="checkbox"/> <b>BKI</b> Black <b>BRI</b> Bronze <b>SLI</b> Silver <input checked="" type="checkbox"/> <b>WHI</b> White <b>CCI</b> Custom Color				<b>CO</b> Surface Mount Conduit Adapter <b>MRA</b> Mud Ring Adapter	
<b>AC/CM/SPM SUSPENSION LENGTH</b>											
Specify the optional cable suspension length in inches. (Top of luminaire to ceiling) (AC & CM 4"-120" Max, Field Adjustable) (SPM 18" Standard, 4"-120" Max; 61"-120" w/LD & ET only and stem comes in 2 sections) *Consult factory & price guide for other lengths.											
<b>VOLTAGE</b>											
<input checked="" type="checkbox"/> <b>UNV</b> Universal 120 - 277 VAC <b>347V</b> 347 VAC (Only SF, SPM, WM Mounts) (0-10V LD dim only) (25L-55L lumen options only). Nominal lumen height restrictions still applicable.											

Soft Field average light loss factor is 0.945

## ACCESSORIES (Order separately.)

**XCR** Remote mount DMX to 0-10V Converter controls (1) or (2) circuits or fixtures w/0-10V Control Driver (LD)

# SSC6 Six-Inch Round Seamless Indoor Cylinder

## LUMENS / WATTAGE nominal

Model	Watts	Lumens
SSC6	6.4 W	500 lm
	9 W	1000 lm
	14 W	1500 lm
	18 W	2000 lm
	23 W	2500 lm
	28 W	3000 lm
	34 W	3500 lm
	38 W	4000 lm
	44 W	4500 lm
	48 W	5000 lm
	53 W	5500 lm
	63 W	6000 lm
	68 W	6500 lm
	72 W	7000 lm
	76 W	7500 lm
	81 W	8000 lm

Lifetime Calculations				
Model	L70	L70	L90	L90
	Calculated	Reported	Calculated	Reported
SSC6	133600	>60500	41200	41200

\*Specific Lumen Output Lifetime available upon request.  
\*All lifetimes based on B50.

IES Multiplier	
Color	Multiplier
927	0.92
930	0.95
935	0.98
940	1.00

\*83CR1s:1.15 Consult factory.

TRIAC & ELV Approved Dimmer List	
Manufacturer	Manufacturer Part Number
Lutron	Glyder GLV-600
	Diva DVLV-600P
	Diva DV-600P
	Diva DVELV-600P(303)
	Maestro MALV-600
	Nova T NT-1000
	Nova T NTELV-600
Leviton	Skylark SLV-600P
	RadioRA2-10ND
	SureSlide 6633
	Illumatech IPE04

0-10V Approved Dimmer List	
Manufacturer	Manufacturer Part Number
Lutron	Diva DVSTV-XX
	Diva DVSTV-453PH-WH1
Leviton	Illumatech 010-IP710-DLZ

## PHOTOMETRICS

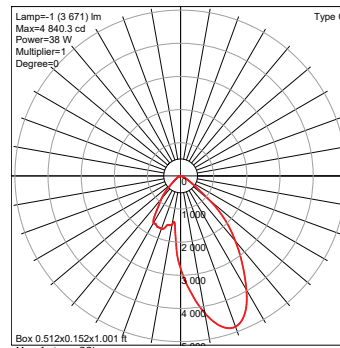
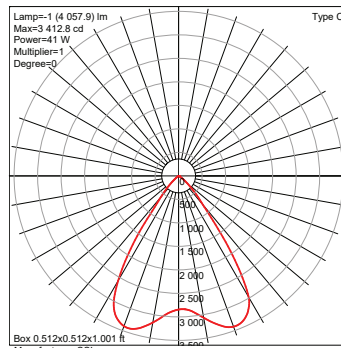
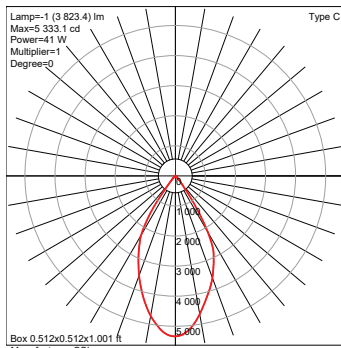
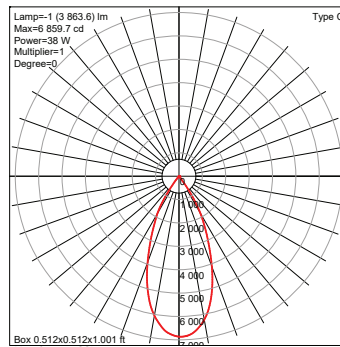
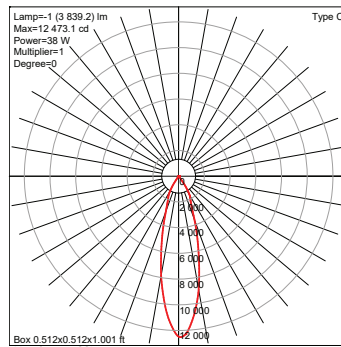
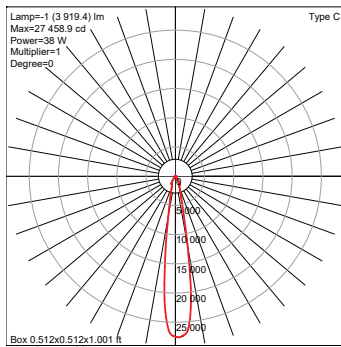

# SSC6 Six-Inch Round Seamless Indoor Cylinder

## CO Option

Surface Mount Conduit Adapter

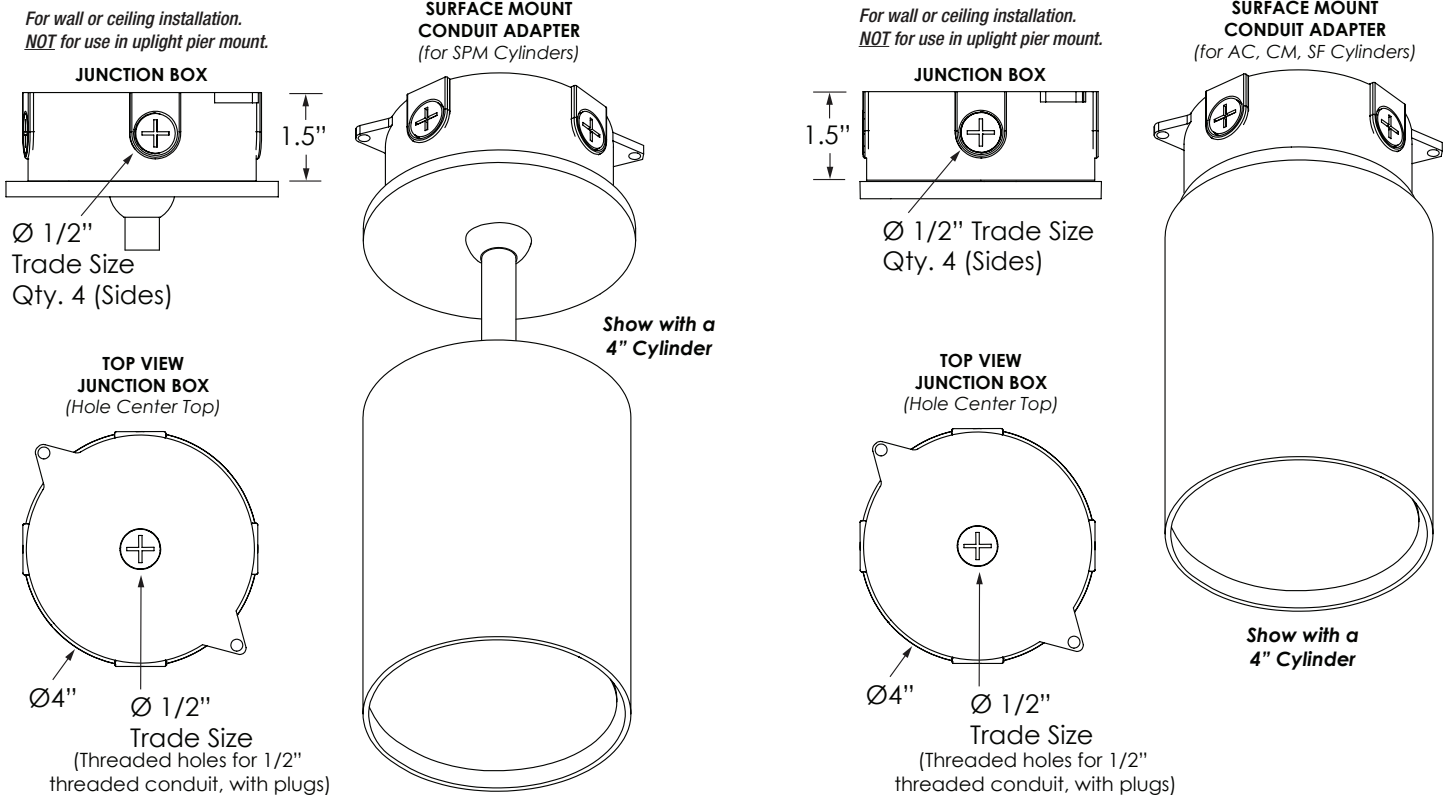

**Surface Mount Conduit Adapter can be added to any of the AC, CM, SF and SPM Mounts**

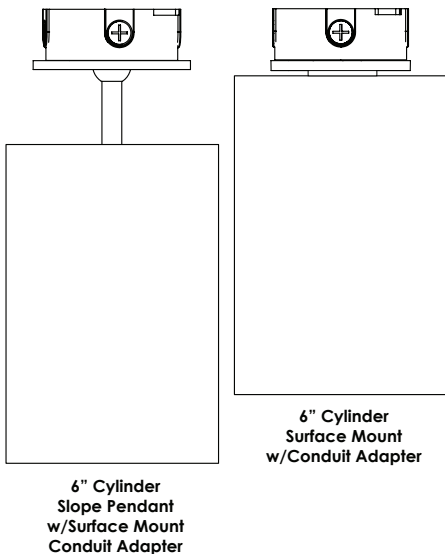

## SSC6 Six-Inch Round Seamless Indoor Cylinder

### MRA Option

Mud Ring Adapter

