

Date: _____

Type: _____

Fixture: _____

Project: _____

Approved: _____

SSC4R Remote Drivers with Battery Backup

4" Round seamless indoor cylinders

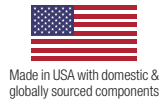

FEATURES

- Up to 31W Max
- No visible seams or fasteners
- Tool-less field interchangeable optics
- Quick twist-lock mounting
- Multiple finish color options
- 1.5G Vibration Tested
- 93 CRI with 2 SDCM

PERFORMANCE

Beam Spread: 15° | 25° | 50° | 72° | 90° | Wall Wash
CCT Options: 2700K, 3000K, 3500K, 4000K, 5700K, TW, DW
CRI: 93 CRI
Consistency: 2 SDCM (Fixture to Fixture)
Lumens: 500-3500 lm
Lifetime: > 70,000 hours / L70 or better

PHYSICAL

Mounting: Aircraft cable, cord, slope pendant, surface, wall w/ twist-lock canopy.
Ingress Protection: Dry or damp locations IP43 rated
Finish: Six stage chemical iron phosphate conversion pre-treatment. Polyester powder coat finish, 18 µm Min., 3000hr salt spray test (ASTM B117) AAMA 2603 specification.
Warranty: 5-Year limited warranty (refer to website for details)
Housing: No visible seams or fasteners, marine grade, corrosion resistant, solid aluminum extrusion, high pressure die-cast aluminum components, black baffle.
Lens: IK05 impact compliant, clear anti-glare tempered glass
Vibration Resistance: Compliant with 1.5G ANSI C136.31, Seismic rated AC-156
Weight: 3-7 lbs (Depending on Length)
Operating Temperature: -22°F to 122°F (-30°C to 50°C)

ELECTRICAL

Voltage: Universal 120-277V AC standard, 347V optional
Power Supply: Integral Class II, electronic high-power factor >.90, THD < 20%, FCC Title 47 Part 15 Class A. EldoLED & Lutron optional.
Power Consumption: Up to 3500 lm / 31W
Dimming: standard: 0-10V Dimming, 1% | optional: ET, XA, XCR, E1, E2, L1, L2, T1, W1
Certification: CEC Title 24 - JA8 Compliant (93 CRI Only)
Standards: cETLus Listed, CE, NOM, and RoHS Compliant, tested to UL 1598 and UL 8750 standards / UL-Class I / IES LM-79 / LM-80 / FCC Part 15

PHYSICAL DIMENSIONS

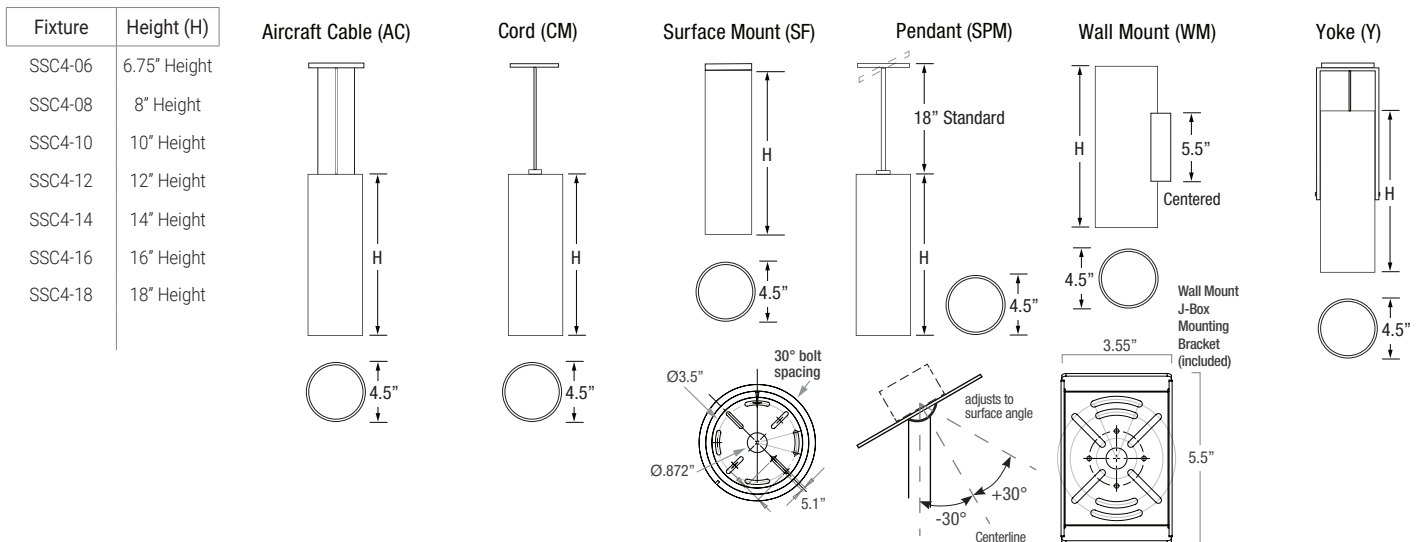

Due to continuous development and improvements, specifications are subject to change without notice. Solid State Luminaires reserves the right to change lab test details or specifications without notice. Product use certifies agreement to Solid State Luminaires terms and conditions. **All stated specifications have a tolerance of +/- 7%.



US Commercial Lighting Manufacturer Since 1982

Date: _____
 Type: _____
 Fixture: _____
 Project: _____

Approved: _____

SSC4R Remote Drivers with Battery Backup

PRODUCT CODE

EXAMPLE: SSC4R-6-SPM18-UNV-930-10L-BKI-15-LD

MODEL	HEIGHT	MOUNTING	SUSP. LENGTH	VOLTAGE	COLOR	LUMENS	FINISH	OPTIC	DIMMING	OPTIONS	BATTERY
SSC4R											

MODEL
SSC4R
 LED DRIVER REMOTE (INDOOR)
 IP20, IK08, NEMA 1, -20°C to +50°C,
 30' MAX Distance with 12AWG

HEIGHT

6	6.75" Height
8	8" Height
10	10" Height
12	12" Height
14	14" Height
16	16" Height
18	18" Height

MOUNTING

AC	Aircraft Cable
CM	Cord Mount
SF	Surface Mount
SPM	Slope Pendant Mount
WM	Wall Mount
Y	Yoke (12" Max)

AC/CM/SPM SUSPENSION LENGTH
 Specify the optional suspension length in inches.
 (Top of fixture to ceiling) (AC & CM 4"-120" Max, Field Adjustable) (SPM 18" Standard, 4"-120" Max; 61"-120" w/LD & ET Only and stem comes in 2 sections) *Consult factory & price guide for other lengths.

VOLTAGE

UNV	Universal 120-277 Volt AC
347V	347 Volt AC (0-10V LD Dim Only) (SF, SPM, WM Only)

COLOR

927	(93CRI) 2700K
930	(93CRI) 3000K
935	(93CRI) 3500K
940	(93CRI) 4000K
TW	Tunable White (2700K-6500K)
DW	Dim-to-Warm (2700K-6500K)

* For 97 CRI Consult Factory

LUMENS nominal

05L	500 lm
10L	1000 lm
15L	1500 lm
20L	2000 lm
25L	2500 lm
30L	3000 lm (Min 8" H)
35L	3500 lm (Min 8" H)

FINISH

BKI	Black (AAMA 2603)
BRI	Bronze (AAMA 2603)
SLI	Silver (AAMA 2603)
WHI	White (AAMA 2603)
CCI	Custom Color (AAMA 2603)

OPTIC nominal	w/SOFT FIELD
15 Spot (15°) (20L Max)	15S Spot (20L Max)
25 Narrow Flood (25°)	25S Narrow Flood
50 Flood (50°)	50S Flood
72 Wide Flood (72°)	72S Wide Flood
90 Very Wide Flood (90°)	90S Very Wide Flood
	WW Wall Wash (25° Only)

DIMMING

LD	0-10V Dimming, 1%
ET	ELV or TRIAC Driver (20L-35L Only)
XA	DMX Dim to 0.1% (Only 10L-35L)
E1	eldoLED 0-10V, Dim to 0.1%, Dim-to-Off (Only 05L-35L)
E2	eldoLED DALI-2 Dim to 0.1% (Only 05L-35L)
L1	Lutron Hi-Lume 1% Ecosystem (Digital Dimming), Soft-on Fade-to-Black (10L-30L)
L2	Lutron Hi-Lume 1% 2-Wire (Forward Phase Dimming) (10L-30L)
T1	0.1%, 0-10V, Tunable White (Only TW) (10L-20L) (Not w/BBUR)
W1	0.1%, 0-10V, Dim-to-Warm (Only DW) (10L-20L) (Not w/BBUR)

OPTIONS

CO	Surface Mount Conduit Adapter
-----------	-------------------------------

BATTERY

BBUR	BATTERY BACK-UP & LED DRIVER REMOTE (INDOOR), IP20, IK08, NEMA 1, 0°C to +48°C, 30' MAX Distance with 12AWG (w/UNV Option Only)
N/A	(Leave blank if No Battery Backup Needed)

ACCESSORIES (Order separately.)

XCR Remote mount DMX to 0-10V Converter controls (1) or (2) circuits or fixtures w/0-10V Control Driver (LD, E1, T1, W1)

SSC4R Remote Drivers with Battery Backup

LUMENS

Model	Watts	940
SSC4R	5 W	500 lm
	8 W	1000 lm
	13W	1500 lm
	18 W	2000 lm
	21 W	2500 lm
	26 W	3000 lm
	31 W	3500 lm

IES Multiplier	
Color	Multiplier
927	0.93
930	0.97
935	0.99
940	1.00

*83CRI≤1.15 Consult factory.

TRIAC & ELV Approved Dimmer List	
Manufacturer	Manufacturer Part Number
Lutron	Glyder GLV-600
	Diva DVLV-600P
	Diva DV-600P
	Diva DVELV-600P(303)
	Maestro MALV-600
	Nova T NT-1000
	Nova T NTELV-600
Leviton	Skylark SLV-600P
	RadioRA2-10ND
	SureSlide 6633
	Illuminatech IPE04

0-10V Approved Dimmer List	
Manufacturer	Manufacturer Part Number
Lutron	Diva DVSTV-XX
	Diva DVSTV-453PH-WH1
Leviton	Illuminatech 010-IP710-DLZ

PHOTOMETRICS

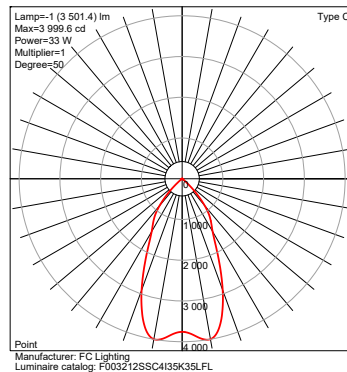
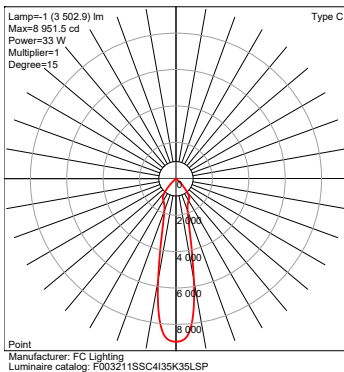

SSC4R Remote Drivers with Battery Backup

CO Option

Surface Mount Conduit Adapter

For wall or ceiling installation.
NOT for use in upright pier mount.

JUNCTION BOX

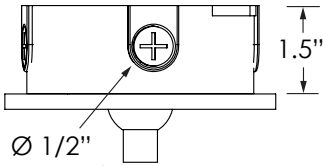

Ø 1/2"
Trade Size
Qty. 4 (Sides)

**TOP VIEW
JUNCTION BOX**
(Hole Center Top)

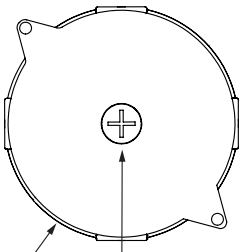

Ø 4"
Ø 1/2"
Trade Size
(Threaded holes for 1/2"
threaded conduit, with plugs)

**SURFACE MOUNT
CONDUIT ADAPTER**
(for SPM Cylinders)

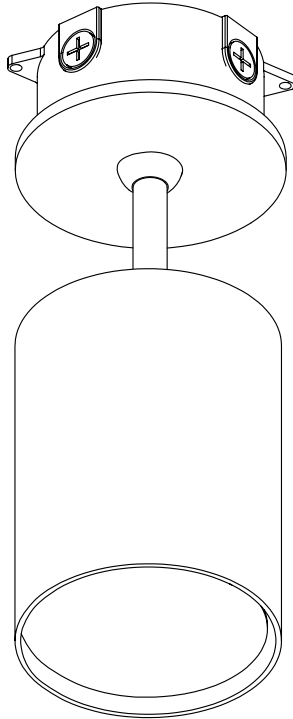

For wall or ceiling installation.
NOT for use in upright pier mount.

JUNCTION BOX

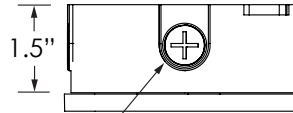

Ø 1/2" Trade Size
Qty. 4 (Sides)

**TOP VIEW
JUNCTION BOX**
(Hole Center Top)

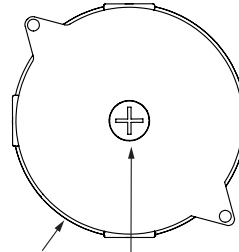

Ø 4"
Ø 1/2"
Trade Size
(Threaded holes for 1/2"
threaded conduit, with plugs)

**SURFACE MOUNT
CONDUIT ADAPTER**
(for AC, CM, SF Cylinders)

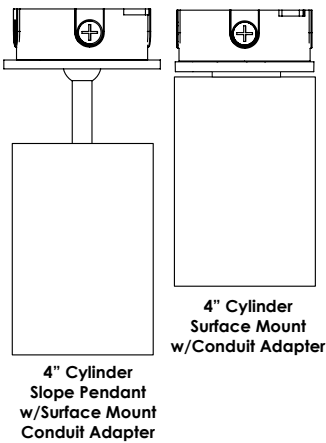
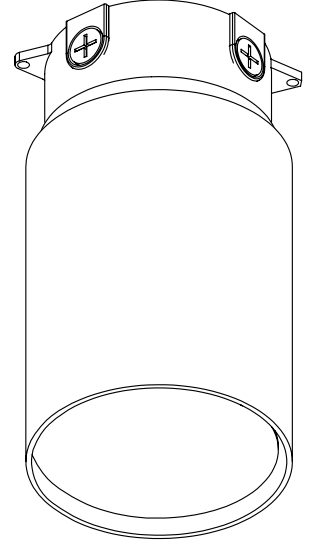

**Surface Mount Conduit Adapter can be added to any
of the AC, CM, SF and SPM Mounts**



SSC4R Remote Drivers with Battery Backup

BATTERY BACK-UPS

BBUR - BATTERY BACK-UP & LED DRIVER REMOTE (INDOOR), IP20, IK08, NEMA 1, 0°C to +48°C, 30' MAX Distance with 12AWG (w/UNV Option Only)

